

Bicycle Station Bicycle Racks

**Bike
File
Bicycle
Rack**



[Bike File](#)

**Decker
Bicycle
Rack**

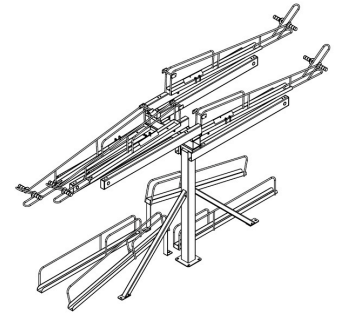

[Double Sided - 8](#)

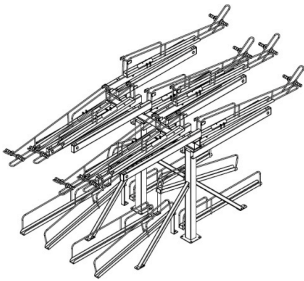

[Double Sided - 16](#)

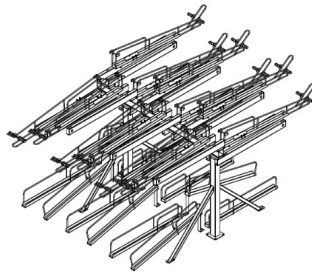

[Double Sided - 24](#)

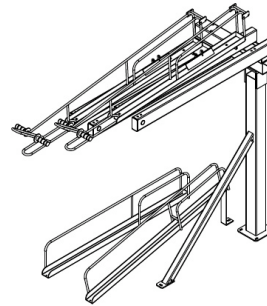

[Single Sided - 4](#)

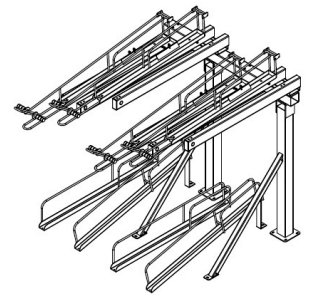

[Single Sided - 8](#)

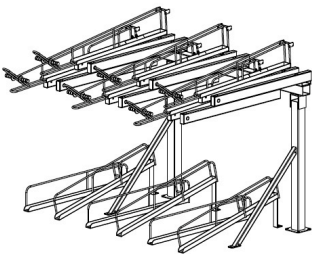

[Single Sided - 12](#)

**Duplex
Bicycle
Racks**

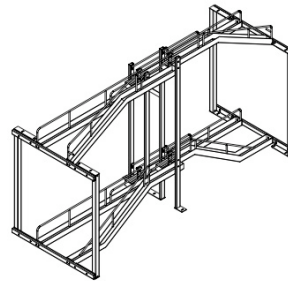

[Double Sided - 8](#)

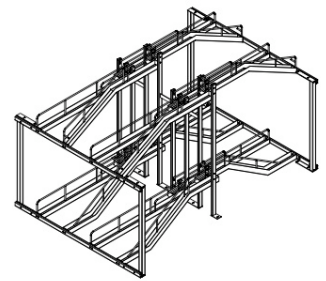

[Double Sided - 16](#)

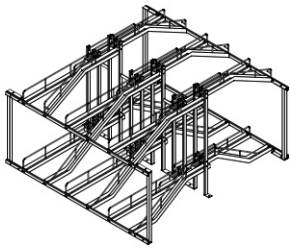

[Double Sided - 24](#)

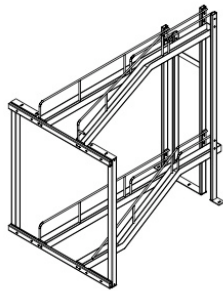

[Single Sided - 4](#)

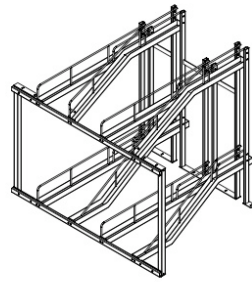

[Single Sided - 8](#)

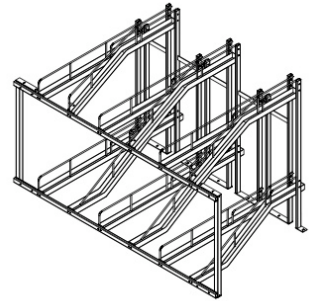

[Single Sided - 16](#)



[Ceiling Mounted](#)

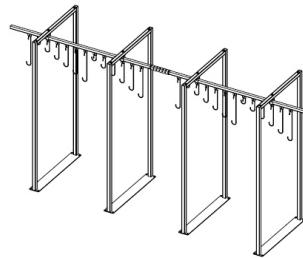

[Floor Mounted](#)



[Wall Mounted](#)

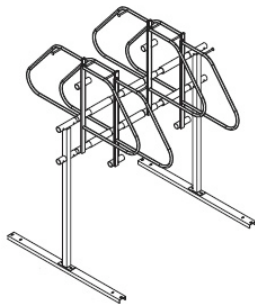

[Two Sided - Floor Mount](#)

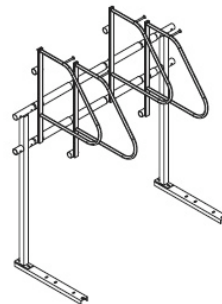

[Single Sided - Floor Mount](#)

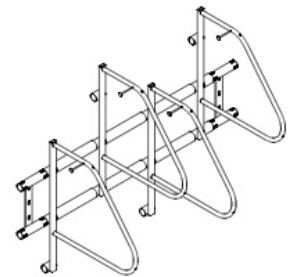

[Singled Sided - Wall Mount](#)

Select product name for details or visit www.streetscapes.biz

Select produc name for details or visit www.streetscapes.biz